



UT2340

Power MOSFET

P-CHANNEL ENHANCEMENT MODE

DESCRIPTION

The UTC **UT2340** is P-Channel enhancement mode Power MOSFET, designed in serried ranks with fast switching speed, low on-resistance and favorable stabilization.

Used in commercial and industrial surface mount applications and suited for low voltage applications such as DC/DC converters.

SYMBOL

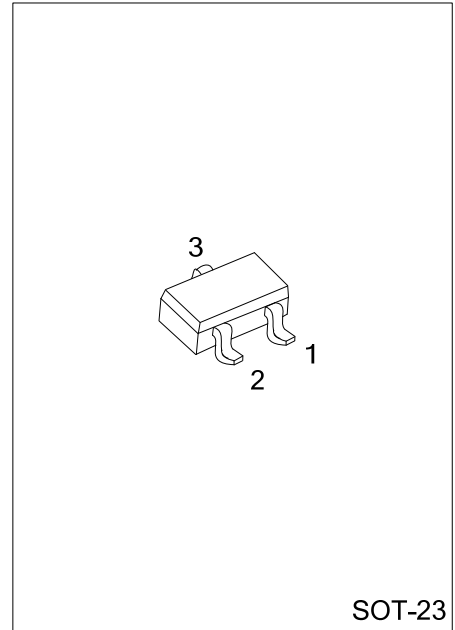
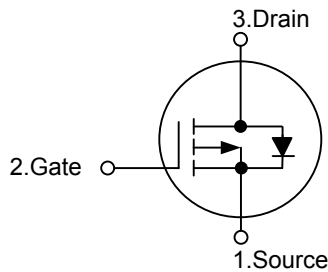

ORDERING INFORMATION

Ordering Number		Package	Pin Assignment			Packing
Lead Free	Halogen Free		1	2	3	
UT2340L-AE3-R	UT2340G-AE3-R	SOT-23	S	G	D	Tape Reel

<p>UT2340L-AE3-R</p> <p>(1) Packing Type</p> <p>(2) Package Type</p> <p>(3) Lead Plating</p>	<p>(1) R: Tape Reel</p> <p>(2) AE3: SOT-23</p> <p>(3) G: Halogen Free, L: Lead Free</p>
--	---

MARKING

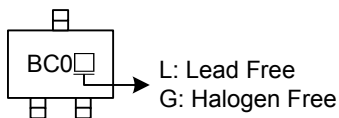

■ ABSOLUTE MAXIMUM RATINGS (Ta = 25°C, unless otherwise specified)

PARAMETER	SYMBOL	RATINGS	UNIT
Drain-Source Voltage	V _{DSS}	-20	V
Gate-Source Voltage	V _{GSS}	±8	V
Continuous Drain Current (Note 3)	I _D	-2	A
Pulsed Drain Current (Note 1, 2)	I _{DM}	-10	A
Total Power Dissipation	P _D	0.46	W
Junction Temperature	T _J	+150	°C
Strong Temperature	T _{STG}	-55 ~ +150	°C

Note: Absolute maximum ratings are those values beyond which the device could be permanently damaged. Absolute maximum ratings are stress ratings only and functional device operation is not implied.

■ THERMAL DATA

PARAMETER	SYMBOL	MIN	TYP	MAX	UNIT
Junction to Ambient (Note 3)	θ _{JA}		250		°C/W
Junction to Case	θ _{JC}		75		°C/W

■ ELECTRICAL CHARACTERISTICS (T_J =25°C, unless otherwise specified)

PARAMETER	SYMBOL	TEST CONDITIONS	MIN	TYP	MAX	UNIT
OFF CHARACTERISTICS						
Drain-Source Breakdown Voltage	BV _{DSS}	V _{GS} =0 V, I _D =-250 μA	-20			V
Drain-Source Leakage Current	I _{DSS}	V _{DS} =-16V, V _{GS} =0 V			-1	μA
Gate-Source Leakage Current	I _{GSS}	V _{GS} = ±8 V, V _{DS} = 0 V			±100	nA
Breakdown Voltage Temperature Coefficient	ΔBV _{DSS} /ΔT _J	I _D =-250μA, Referenced to 25°C		-15		mV/°C
ON CHARACTERISTICS						
Gate Threshold Voltage	V _{GS(TH)}	V _{DS} =V _{GS} , I _D =-250 μA	-0.4	-0.9	-1.5	V
Drain-Source On-State Resistance (Note 2)	R _{DS(ON)}	V _{GS} =-4.5V, I _D =-2A		52	70	mΩ
		V _{GS} =-2.5 V, I _D =-1.7A		78	110	mΩ
		V _{GS} =-1.8V, I _D =-1.2A			210	mΩ
DYNAMIC PARAMETERS						
Input Capacitance	C _{ISS}	V _{DS} =-10V, V _{GS} =0V, f=1.0MHz		600		pF
Output Capacitance	C _{OSS}			175		pF
Reverse Transfer Capacitance	C _{RSS}			80		pF
SWITCHING PARAMETERS						
Turn-ON Delay Time (Note 2)	t _{D(ON)}	V _{DD} =-5V, I _D =-0.5A, V _{GS} =-4.5V, R _{GEN} =6 Ω		6	12	ns
Turn-ON Rise Time	t _R			9	18	ns
Turn-OFF Delay Time	t _{D(OFF)}			31	50	ns
Turn-OFF Fall Time	t _F			26	42	ns
Total Gate Charge (Note 2)	Q _G	V _{DS} =-10V, V _{GS} =-4.5V, I _D =-2A		8	11	nC
Gate-Source Charge	Q _{GS}			1.3		nC
Gate-Drain Charge	Q _{GD}			2.2		nC
DRAIN-SOURCE DIODE CHARACTERISTICS AND MAXIMUM RATINGS						
Drain-Source Diode Forward Voltage(Note2)	V _{SD}	V _{GS} =0V, I _S = -0.42A (Note)		-0.7	-1.2	V
Maximum Continuous Drain-Source Diode Forward Current	I _S				-0.42	A

Notes: 1. Pulse width limited by T_{J(MAX)}

2. Pulse width ≤300μs, duty cycle ≤2%.

3. Surface mounted on 1 in² copper pad of FR4 board; 270°C/W when mounted on min.

TYPICAL CHARACTERISTICS

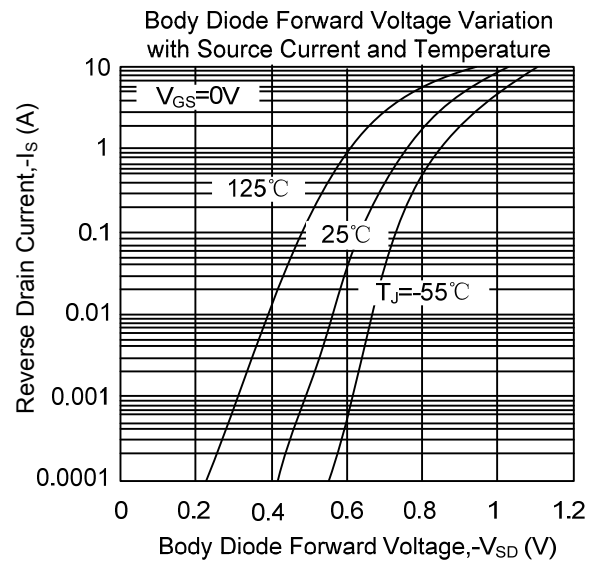
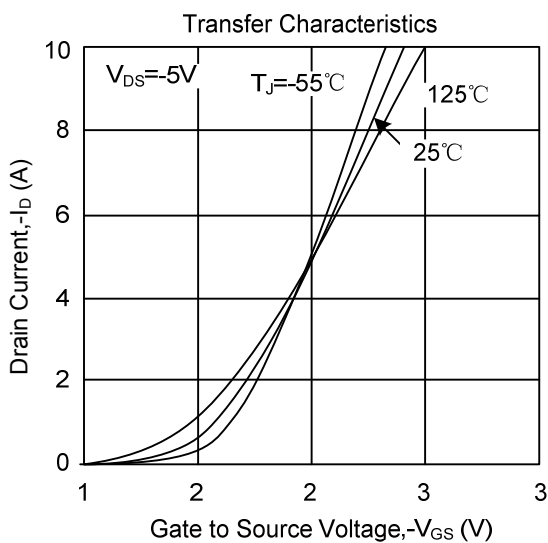
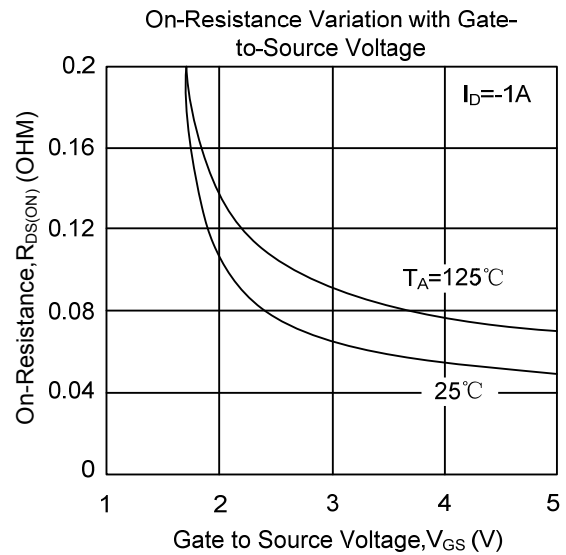
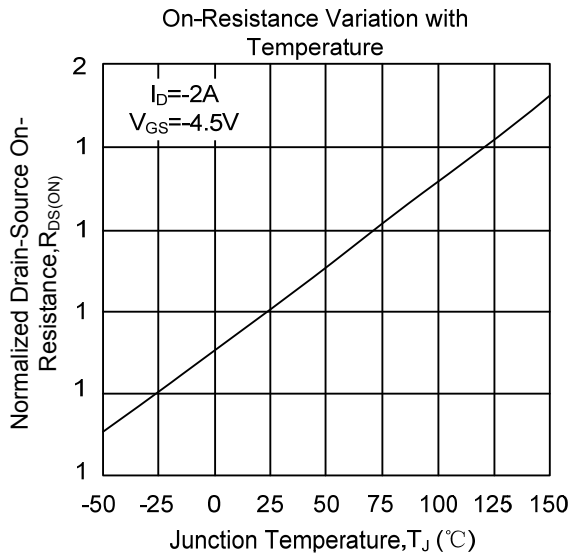
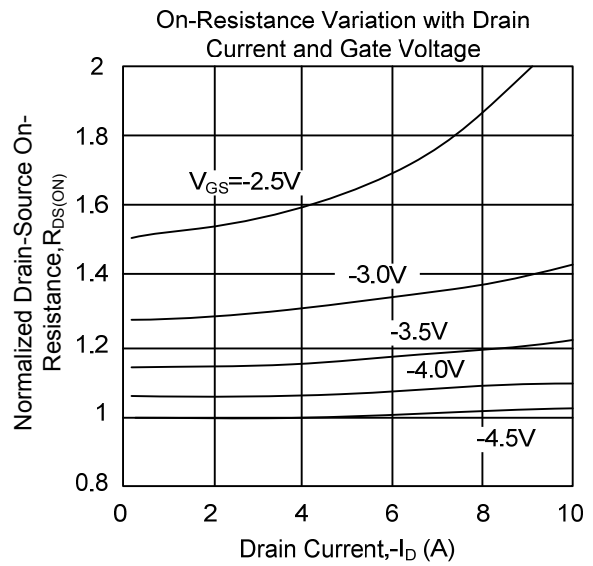
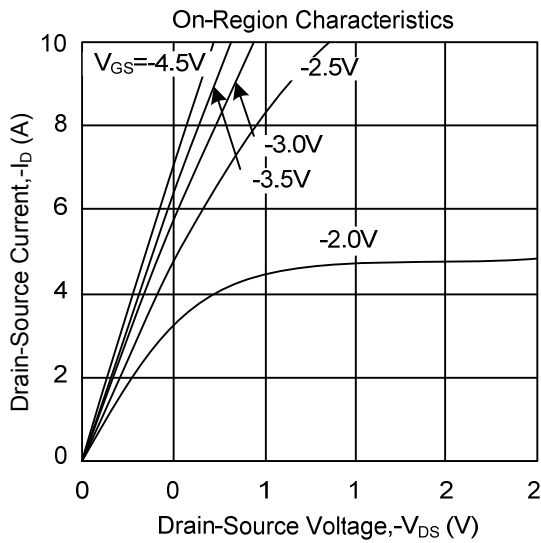

TYPICAL CHARACTERISTICS(Cont.)

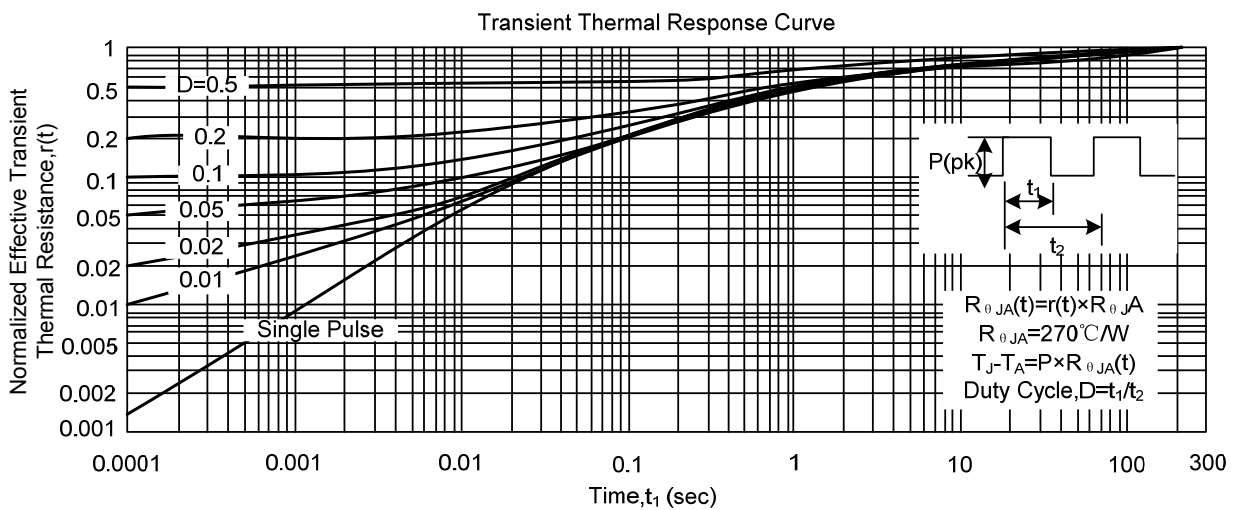
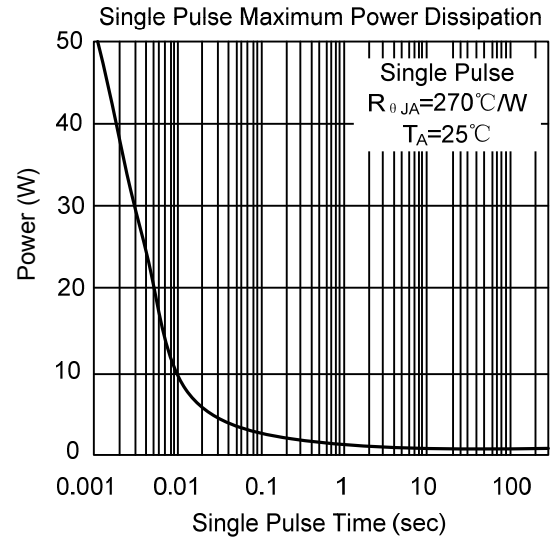
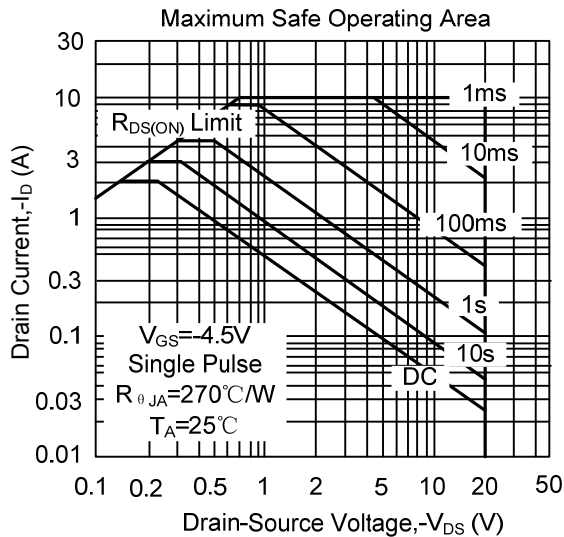
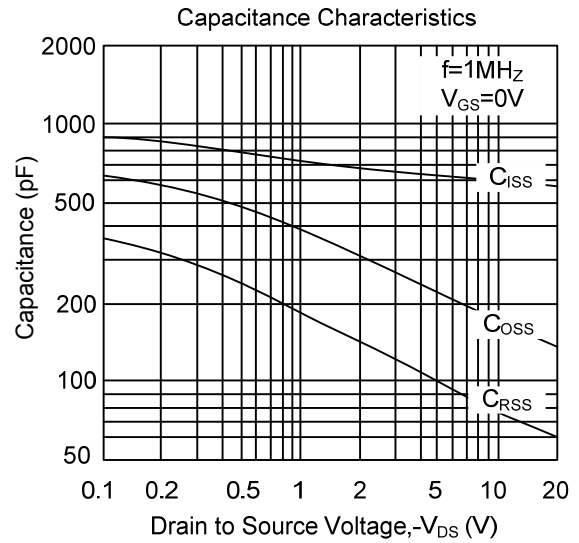
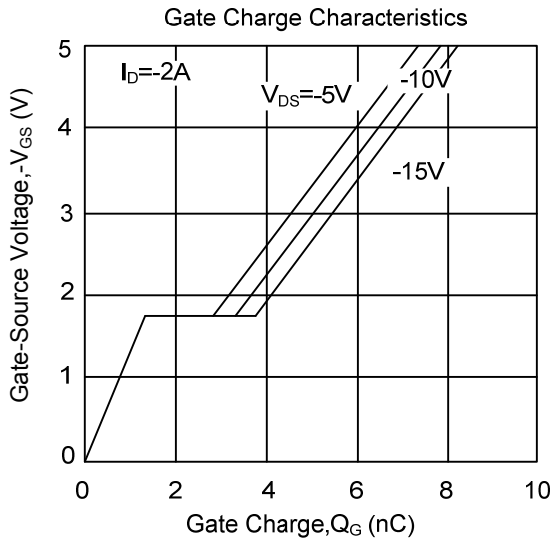

UTC assumes no responsibility for equipment failures that result from using products at values that exceed, even momentarily, rated values (such as maximum ratings, operating condition ranges, or other parameters) listed in products specifications of any and all UTC products described or contained herein. UTC products are not designed for use in life support appliances, devices or systems where malfunction of these products can be reasonably expected to result in personal injury. Reproduction in whole or in part is prohibited without the prior written consent of the copyright owner. The information presented in this document does not form part of any quotation or contract, is believed to be accurate and reliable and may be changed without notice.